

SES HD SERIES - THREE PHASE - **3 WIRE** - 6 to 600 kVA

COST EFFICIENT VOLTAGE STABILISATION
with fast speed of response, high output voltage accuracy and inbuilt energy saving ability.

FEATURES

- **Automatic Voltage Regulation**
Step less automated voltage regulation - ideal for 95% of all applications.
- **Wide Range of Power Ratings**
Three Phase 6 to 600 KVA
- **Broad Input Voltage Swing Ranges**
Input Swing - $\pm 15\%$ (S15), $\pm 20\%$ (S20), $\pm 25\%$ (S25), $\pm 30\%$ (S30), $\pm 35\%$ (S35) & $\pm 40\%$ (S40) - to specify.
- **Precise Output Voltage Regulation**
Output Voltage Accuracy $\pm 1\%$
- **Transient Voltage Surge Suppression**
TVSS - Protects loads against harmful high-energy surges, transients and spikes.
- **High Efficiency**
Better than 98% for low running costs.

**SERVO ELECTRONIC DESIGN****AC VOLTAGE STABILISERS & REGULATORS****AC THREE PHASE** - 6 TO 600 kVA - **3 WIRE** - NO NEUTRAL**SES****380V - 400V - 415V - 50/60Hz****HD - THREE PHASE****ENSURING A STABLE AC MAINS VOLTAGE**

AC mains voltage fluctuations can cause equipment to behave erratically and malfunction. Some systems may even break down due to these fluctuations, noise or spikes. Failure to ensure the incoming mains voltage is stable and clean can often result in costly equipment repairs and unplanned down-time.

Ashley-Edison AC Voltage Stabilisers offer -

- **Voltage Stability & Protection**
Suitable for all electrical and electronic equipment, Ashley-Edison's SES AC Voltage Stabilisers continuously monitor the incoming supply. Should the incoming voltage rise or drop, the Stabilisers will automatically control the output to ensure the voltage reaching the load equipment always remains constant at the requisite voltage. With inbuilt Transient Voltage Surge Suppression (TVSS), they also protect electrical and electronic load equipment against, all to common, harmful high-energy surges, transients and voltage spikes.
- **Durability & Dependability**
With an impressively wide range of input voltage window options and precise tight output voltage regulation, the electro-mechanical / servo electronic design based SES Voltage Stabilisers have repeatedly proven their durability and dependability in some of the world's harshest and most demanding power environments. All SES AC Voltage Stabilisers include as standard many advanced protection and control features - such as Independent Phase Sensing, TVSS, Input Circuit Breaker, Bypass Control Switch and Soft-Switch On, which others only offer as expensive add-on options.
- **Energy Efficiency**
Configured to optimise energy usage and deliver energy cost savings, SES Stabilisers generate no magnetic interference, are completely unaffected by power factor, or load and frequency variations and are capable of withstanding high instantaneous overloads. Their compact and quiet nature means these they are suitable for indoor use and may be located near to sensitive equipment.
- **Unparalleled Protection and Value**
When looking for affordable durable Quality voltage protection, the SES Range of AC Voltage Stabilisers from Ashley-Edison lead the market in all respects.
- **Independent Phase Balancing & Control**
Independent phase voltage sensing and control to ensure the individual phase voltages remain stable - regardless of load unbalance .
- **Inbuilt High Overload Capability**
Ideal for loads with an inherent initial high current draw on start up.
- **Soft-Switch On / Start Up Load Protection**
Protection of the load from momentary over voltage situations on start up.
- **Over / Low Voltage Protection**
Ability to automatically shutdown the Voltage Stabiliser in the event of the input supply voltage going outside the input voltage window.
- **Bypass Control Switch**
Manual Electronic Controls Bypass Facility
- **Phase Failure Protection**
Protection of the load in the event of phase failure.
- **Front Panel Status Monitoring & Metering**
Front Panel display showing system status with internal output Voltmeter with phase selector switch.
- **Input Circuit Breaker**
Input over current protection fitted as standard.
- **Optional Accessories**
Output Circuit Breaker, Manual Maintenance Bypass Switch, Ammeter with Phase Selector Switch, No Volt Remote Monitoring Contacts, Digital Power Metering (with RS-485 interface option) & Lightning Arrestors.
- **Compliance with International Standards**
Designed, manufactured and supplied to comply with leading international standards
- **CE Conformity**
Fully compliant and labelled

VOLTAGE CHOICES AVAILABLE

Also available as 4 Wire Solutions (with Neutral) - **SES-H & LY SERIES**

3 WIRE SOLUTIONS

THREE PHASE (+ GROUND / EARTH) - **NO NEUTRAL**

HD SERIES

6 to 600 kVA

High Voltage Models:

380V, 400V or 415V.

440V, 460V or 480V also available.



LD SERIES

6 to 400kVA

Low Voltage Models:

190V, 200V, 208V, 220V

or 240V.

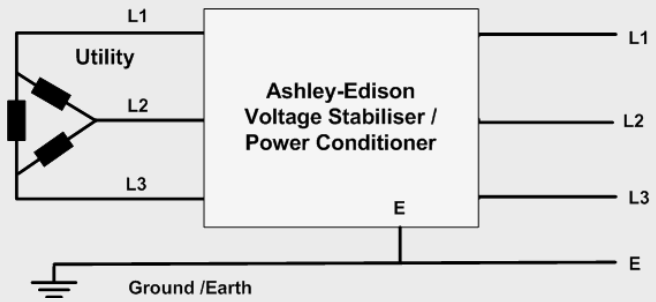

HD SERIES INPUT VOLTAGE WINDOW OPTIONS

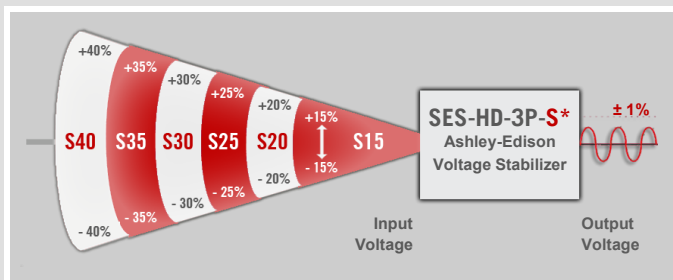

In situations where there is a reasonably good mains supply, a Stabiliser offering an input variation swing of $\pm 15\%$ (S15 Models) will usually be more than acceptable, but in more remote locations, or countries where the national supply infrastructure is less developed, variations of $\pm 20\%$ or greater may be needed to be accommodated by the Stabiliser.

Please Note – These Stabilisers are not designed to support / protect voltage “back feed” applications, where energy is required to be also fed back into the utility supply.

HD SERIES - SES-HD-3P-S* Input Voltage Windows & Output Accuracy

Nominal Three Phase Voltage	Output Voltage Accuracy \pm % of Nominal	INPUT VOLTAGE SWINGS / SWING MODEL NO VARIANTS					
		S15	S20	S25	S30	S35	S40
		6 to 600 kVA	6 to 600 kVA	6 to 500 kVA	6 to 400 kVA	6 to 300 kVA	6 to 300 kVA
380V	$\pm 1\%$	323v to 437v ($\pm 15\%$)	304v to 456v ($\pm 20\%$)	285v to 475v ($\pm 25\%$)	266v to 494v ($\pm 30\%$)	247v to 513v ($\pm 35\%$)	228v to 532v ($\pm 40\%$)
	$\pm 3\%$	315v to 448v (-17% / +18%)	296v to 467v (-22% / +23%)	277v to 486v (-27% / +28%)	258v to 505v (-32% / +33%)	239v to 524v (-37% / +38%)	220v to 543v (-42% / +43%)
	$\pm 5\%$	308v to 460v (-19% / +21%)	289v to 479v (-24% / +26%)	270v to 498v (-29% / +31%)	251v to 517v (-34% / +36%)	232v to 536v (-39% / +41%)	213v to 555v (-44% / +46%)
400V	$\pm 1\%$	340v to 460v ($\pm 15\%$)	320v to 480v ($\pm 20\%$)	300v to 500v ($\pm 25\%$)	280v to 520v ($\pm 30\%$)	260v to 540v ($\pm 35\%$)	240v to 560v ($\pm 40\%$)
	$\pm 3\%$	332v to 472v (-17% / +18%)	312v to 492v (-22% / +23%)	292v to 512v (-27% / +28%)	272v to 532v (-32% / +33%)	252v to 552v (-37% / +38%)	232v to 572v (-42% / +43%)
	$\pm 5\%$	324v to 484v (-19% / +21%)	304v to 504v (-24% / +26%)	284v to 524v (-29% / +31%)	264v to 544v (-34% / +36%)	244v to 564v (-39% / +41%)	224v to 584v (-44% / +46%)
415V	$\pm 1\%$	353v to 477v ($\pm 15\%$)	332v to 498v ($\pm 20\%$)	311v to 519v ($\pm 25\%$)	291v to 540v ($\pm 30\%$)	270v to 560v ($\pm 35\%$)	249v to 581v ($\pm 40\%$)
	$\pm 3\%$	344v to 490v (-17% / +18%)	324v to 510v (-22% / +23%)	303v to 531v (-27% / +28%)	282v to 552v (-32% / +33%)	261v to 573v (-37% / +38%)	241v to 593v (-42% / +43%)
	$\pm 5\%$	336v to 502v (-19% / +21%)	315v to 523v (-24% / +26%)	295v to 544v (-29% / +31%)	274v to 564v (-34% / +36%)	253v to 585v (-39% / +41%)	232v to 606v (-44% / +46%)

TYPICAL APPLICATIONS

- Computers & Network Systems
- Medical Equipment
- Electronics Equipment
- Testing Equipment
- Laboratory Equipment
- POS Terminals
- Process Control Systems
- TV/Radio Broadcasting Stations
- Audio/Video Systems
- Security Systems
- Elevators / Lifts
- CNC & SMT Equipment



TECHNICAL SPECIFICATION

380V - 400V - 415V - 50/60Hz

Technology:	Servo Electronic - Variable Transformer controlled, series regulation transformer (buck-boast transformer with secondary wired in series with the load).			
Input Voltage Swing Variant Options Available (S*):	Model / Accuracy	± 1%	± 3%	± 5%
	S15	± 15%	-17% +18%	-19% +21%
	S20	± 20%	-22% +23%	-24% +26%
	S25	± 25%	-27% +28%	-29% +31%
	S30	± 30%	-32% +33%	-34% +36%
	S35	± 35%	-32% +33%	-34% +36%
	S40	± 40%	-42% +43%	-44% +46%
	Three Phase, 3 Wire (3 Phase + G/E) - No Neutral Other swing options available to special quotation / order.			
Output Voltage:	Presetable for any voltage between 380V, 400V or 415V (Customer to specify), Three Phase, 3 Wire. The permissible input voltage swing is relative to the selected output voltage.			
Output Voltage Accuracy:	± 1%, ± 3% or ± 5% - auto selection based on input voltage swing.			
Frequency:	47 - 65Hz			
Response Time:	<1.5ms			
Correction Time:	A 10% supply variation will be corrected to within 2.5% in 0.6 seconds.			
Efficiency:	98%			
Power Factor:	Any lagging to 0.95 leading			
Surge Ratings:	10 x max. current rating for 2 seconds 3 x max. current rating for 1 minute 2 x max. current rating for 2 minutes			
Surge Suppression:	TVSS - Protects loads against high-energy Spikes and Transient Voltages.			
Total Harmonic Distortion:	Less than 1%			
Independent Phase Control:	Maintains each phase voltage stable irrespective of load unbalance, even up to 100% load unbalance.			

Soft-Switch On:	Ensures the output voltage is set at minimum upon Switch-On before commencing stabilization - protects load equipment from damaging start up voltage surges.
Environment:	Temperature range -15 to 45 °C. Derate by 2% for each additional °C Up to max 60 °C . Suitable for indoor tropical use 95% RH (non-condensing). Maximum altitude 1000m. Derate by 2.5% for each additional 500m.
Construction:	Enclosures to IP20 (NEMA 1 Style) Ingress Protection - BS EN 60529.
Paint Colour:	RAL 7032 (Grey - Epoxy Powder Coating)
EMC Conformance:	Complies with BS EN 55022 and the relevant parts of the BS EN 61000 series of standards.
CE Conformity:	CE Marked - being fully compliant with European Union Directives 2004/108/EC (The EMC Directive) and 2006/95/EC (The Low Voltage Directive).
Standard Warranty:	Three Years / 36 Months from date of supply
Standard Features:	Input Circuit Breaker Over/Low Voltage Protection Phase Failure Protection Bypass Control Switch Voltmeter / Phase Selector Switch (internal)
Optional Accessories:	Output Circuit Breaker Manual Maintenance Bypass Switch Ammeter (with Phase Selector Switch) Lightning Surge Arrestors No Volt Remote Monitoring Contacts Drip Proof Cowl for IP21 Ingress Protection Digital Power Metering (with RS-485 interface) - showing V, A, W, VA, AER, PF & kWh AquaStop Protective Coating - protection against damp and moisture ingress
Optional Step Down Voltage Feature:	Ideal for applications where the utility supply voltage is different from the load equipment's requirement - see SES-HLD SERIES Step Down AC Voltage Stabilizers.
Optional Isolation Transformer:	Shielded isolation transformer providing extra protection between the utility and the load. Protects against common and transverse mode electrical noise - see PCS-HD SERIES AC Power Conditioners.

Note: Optional Accessories added may affect dimensions - subject to confirmation.

PRODUCT SELECTION TABLE

MODEL	kVA	Max Rating @ (Amps per Phase)			Dimensions & Weight
		380V	400V	415V	
SES-6HD-3P-S*	6	9.1	8.7	8.3	<i>Dimensions, Weights & Enclosure Types available on Request - according to the S* Swing Model Variant required.</i>
SES-10HD-3P-S*	10	15.2	14.4	13.9	
SES-15HD-3P-S*	15	22.8	21.6	20.9	
SES-20HD-3P-S*	20	30.4	28.9	27.8	
SES-25HD-3P-S*	25	38	36.1	35	
SES-30HD-3P-S*	30	46	43	42	
SES-35HD-3P-S*	35	53	51	49	
SES-40HD-3P-S*	40	61	58	56	
SES-45HD-3P-S*	45	68	65	63	
SES-50HD-3P-S*	50	76	72	70	
SES-55HD-3P-S*	55	84	79	77	
SES-60HD-3P-S*	60	91	87	83	
SES-75HD-3P-S*	75	114	108	104	
SES-80HD-3P-S*	80	122	115	111	

Note: Higher kVA and alternative voltage options available to order / individual request.

Copyright 2013 © Ashley-Edison (UK) reserve the right to change any or all the specifications indicated or implied without prior notice. E&EO.

ALSO available in Outdoor IP 54 (NEMA 3 Style) Enclosures - **OSES SERIES**

MODEL	kVA	Max Rating @ (Amps per Phase)			Dimensions & Weight
		380V	400V	415V	
SES-90HD-3P-S*	90	137	130	125	<i>Dimensions, Weights & Enclosure Types available on Request - according to the S* Swing Model Variant required.</i>
SES-100HD-3P-S*	100	152	144	139	
SES-120HD-3P-S*	120	182	173	167	
SES-150HD-3P-S*	150	228	216	209	
SES-180HD-3P-S*	180	273	260	250	
SES-200HD-3P-S*	200	304	289	278	
SES-250HD-3P-S*	250	380	361	348	
SES-300HD-3P-S*	300	456	433	417	
SES-350HD-3P-S*	350	532	505	487	
SES-400HD-3P-S*	400	608	577	556	
SES-450HD-3P-S*	450	684	649	626	
SES-500HD-3P-S*	500	760	722	695	
SES-600HD-3P-S*	600	911	866	835	

STANDARD ENCLOSURE TYPES

ALSO available in Outdoor IP54 / NEMA 3 Style Enclosures - **OSES SERIES**

331 & 332 Enclosures

On Casters

Front

Rear

Right Side

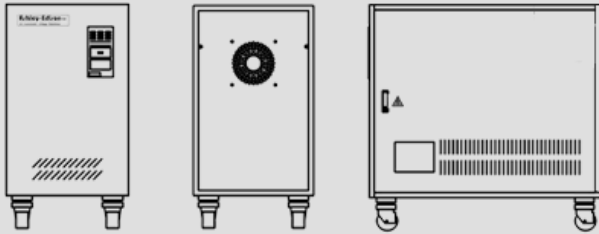

Physical Size:

331	300(W) x 550(H) x 590(D) mm	(11.9"(W) x 21.7"(H) x 23.3"(D) inches)
332	380(W) x 670(H) x 780(D) mm	(15.0"(W) x 26.4"(H) x 30.8"(D) inches)

333 & 334 Enclosures

On Casters

Front

Rear

Right Side

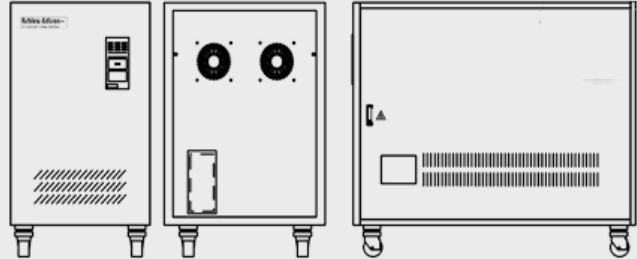

Physical Size:

333	490(W) x 800(H) x 990(D) mm	19.3"(W) x 31.5"(H) x 39.0"(D) inches
334	540(W) x 900(H) x 1000(D) mm	21.3"(W) x 35.5"(H) x 39.4"(D) inches

335 Enclosure

Front

Rear

Left Side

Right Side

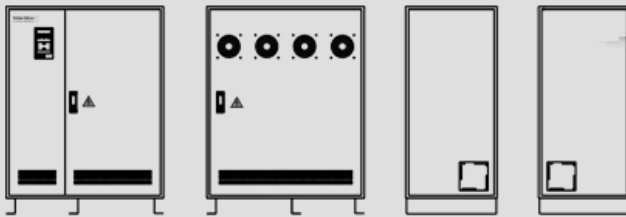

Physical Size:

335	1000(W) x 1300(H) x 580(D) mm	39.4"(W) x 51.2"(H) x 22.9"(D) inches
------------	-------------------------------	---------------------------------------

336, 337 & 338 Enclosures

Front

Rear

Left Side

Right Side

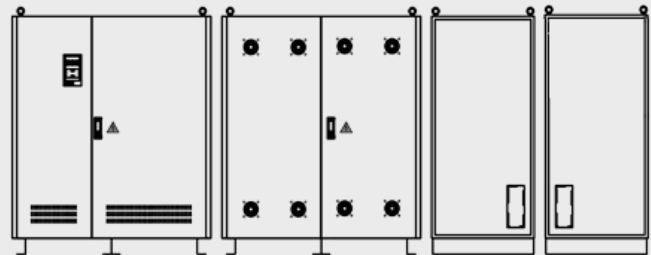

Physical Size:

336	1280(W) x 1480(H) x 660(D) mm	50.4"(W) x 58.3"(H) x 26.0"(D) inches
337	1280(W) x 1950(H) x 820(D) mm	50.4"(W) x 76.8"(H) x 32.3"(D) inches
338	1280(W) x 1950(H) x 1200(D) mm	50.4"(W) x 76.8"(H) x 47.3"(D) inches

AVAILABILITY

We offer probably the best availability on AC Voltage Stabiliser & Power Conditioning solutions.

Many of our most popular ratings are readily available from stock at the factory or from one of our strategically located Service and Distribution Hubs. Where a solution is not readily available, due to our considerable investment in component inventory and fine-tuned accredited build processes, we are able to ensure very short lead times on deliveries – *even for the largest of models!*

WANT TO KNOW MORE

Want to learn more about our Servo Electronic AC Voltage Regulators / Stabilisers and Power Conditioners?

Please ask for a copy of our

Servo Electronic Overview Brochure

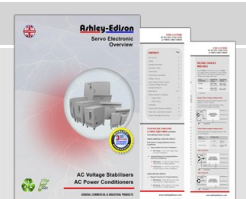

CUSTOM BUILT SOLUTIONS

Ashley-Edison, with a strong and wide manufacturing base, is able to meet the requirements of customers from our own in-house professional resources.

Where bespoke / custom built solutions are required we are able to call upon our extensive portfolio of proven standard designs and tailor offerings to accommodate, without breaking the bank, most individual specific requirements.

Copyright 2013 © Ashley-Edison (UK) reserve the right to change any or all the specifications indicated or implied without prior notice. E&EO.

